



Forming Tomorrow. Today!

The Complete Range of Fluid Power Products



Electropneumatics & Hydraulics (India) Pvt. Ltd. | Fluid Power Division (FPD)

Electropneumatics Fluid Power Division (FPD)

Electropneumatics and Hydraulics (I) Pvt. Ltd. started its Fluid Power Division with the manufacture of pneumatic valves in 1972. From pneumatic valves, it progressed into making pneumatic cylinders, hydraulic cylinders and hydraulic power units in the following years.

The Division has been designing and manufacturing valves and cylinders for more than 40 years for 24x7 application in different industry sectors like automotive, chemical, steel, pharmaceutical, foundry, machine tool, plastics, textile, packaging, mobile and general engineering. Besides standard products, tailored products are also made to meet customer-specific applications.

The proven designs, ruggedness and stringent testing cycles result in reliable, trouble-free and consistent operations, even in the harshest of environments. The product range encompasses:

- Pneumatic Valves
- Pneumatic Cylinders
- Air-Line Accessories
- Hydraulic Cylinders
- Hydraulic Power Packs and Systems



Pneumatic Valves, 2-way, 2-position (Solenoid / pilot operated)

Features

- 2/2 In-line direct acting, diaphragm type and pilot piston actuated valves
- Suitable for air, water and low pressure oil media
- Port sizes up to G 4
- Bubble tight shut off, quick response to actuation
- Mounts in any position
- Continuous duty cycle coil
- Material: Body- brass/gunmetal, Cover- aluminium/brass, Seals- nitrile
- Options: 2/2 NC, NO in solenoid and pilot version, Auto drain valve
- Specials: High pressure 2/2 valve up to 28 bar
- Application: Drain and dispensing



Available types

2/2 NC Solenoid

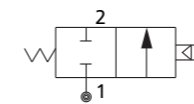

2/2 NO Solenoid

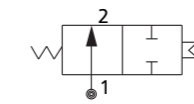

2/2 NC External Pilot

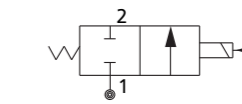

2/2 NO External Pilot

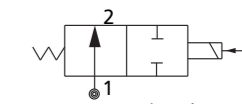

(1- Inlet, 2- Outlet)

Specifications

Direct acting

Port Size	Orifice dia	Pressure psi	Flow lpm	Material	Weight kg	Part Code	
						Normally closed	Normally open
*G 1/8	1/16"	0 – 125	150	Al	0.2	PVS2018GARADNC1	PVS2018GARADNO1
*G 1/4	1/16"	0 – 125	150	Al	0.2	PVS2014GARADNC1	PVS2014GARADNO1
G 1/2	3/8"	0 – 30	2400	GM	0.4	PVS2012GARGDNC1	—
G 3/4	3/8"	0 – 30	3000	GM	0.5	PVS2034GARGDNC1	—
G 1	3/8"	0 – 30	3000	GM	0.6	PVS2100GARGDNC1	—
G 1 1/4	5/8"	0 – 30	3500	GM	1.4	PVS2114GARGDNC1	—
G 1 1/2	5/8"	0 – 30	3500	GM	1.5	PVS2112GARGDNC1	—

* 3/2 NC and NO versions are also available in G 1/8 and G 1/4 sizes

Diaphragm type

BSP	dia	psi	lpm	Material	kg	Normally closed	Normally open
G 1/2	1/2"	5 – 125	2400	Brass	0.9	PVS2012GDPBINC1	PVS2012GDPBINO1
G 3/4	1"	5 – 125	8000	Brass	1.2	PVS2034GDPBINC1	PVS2034GDPBINO1
G 1	1"	5 – 125	8000	Brass	1.2	PVS2100GDPBINC1	PVS2100GDPBINO1

Solenoid- external pilot operated

BSP	dia	psi	lpm	Material	kg	Normally closed	Normally open
G 1/2	3/8"	20 – 125	2400	GM	0.4	PVS2012GARGENC1	PVS2012GARGENO1
G 3/4	1/2"	20 – 125	3000	GM	0.5	PVS2034GARGENC1	PVS2034GARGENO1
G 1	5/8"	20 – 125	3500	GM	0.6	PVS2100GARGENC1	PVS2100GARGENO1
G 1 1/4	3/4"	20 – 125	6000	GM	1.4	PVS2114GARGENC1	PVS2114GARGENO1
G 1 1/2	7/8"	20 – 125	7000	GM	1.5	PVS2112GARGENC1	PVS2112GARGENO1
G 2	1 3/8"	20 – 125	12000	GM	2.3	PVS2200GARGENC1	PVS2200GARGENO1

• Pilot pressure ≥ Inlet pressure • For pilot-operated valve, put 'P' instead of 'S' in Part Code • For complete details, refer Product Data Sheet.



Pneumatic Valves, 3-and 4-way, 2-position (Solenoid / pilot operated)



- 5/2, 3/2 NO and NC high flow capacity poppet valve
- Sturdy and reliable poppet design
- Port sizes up to G 1 1/2
- Low power solenoid with a range of AC/DC voltages
- Speed up to 600 cycles/min, life up to 10 million cycles
- Manual override as a standard feature
- Material: Body, Piston, Housing- aluminium, Seals- nitrile
- Options: 3/2 NO, NC and 5/2 valve in solenoid and pilot version
- Application: Single-acting and double-acting cylinders

Available types

5/2 Single Solenoid

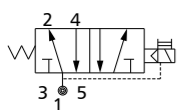

5/2 Single Pilot

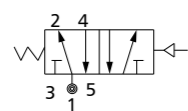

5/2 Double Solenoid

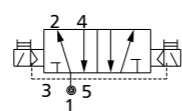

5/2 Double Pilot

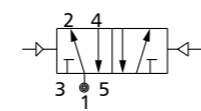

(1-Inlet, 2,4- Outlet, 3,5- Exhaust)

Specifications

3-way (3/2)

Port Size	Orifice	Pressure	Flow	Material	Weight	Part Code (solenoid opt.)	
						Normally closed	Normally open
BSP	dia	psi	lpm		kg		
G 1/4	1/4"	25 – 125	1000	Al	0.3	PVS3014GPPAINC1	PVS3014GPPAINO1
G 3/8	3/8"	25 – 125	2000	Al	0.7	PVS3038GPPAINC1	PVS3038GPPAINO1
G 1/2	1/2"	25 – 125	2400	Al	0.7	PVS3012GPPAINC1	PVS3012GPPAINO1
G 3/4	3/4"	25 – 125	5500	Al	1	PVS3034GPPAINC1	PVS3034GPPAINO1
G 1	1"	25 – 125	7000	Al	1.8	PVS3100GPPAINC1	PVS3100GPPAINO1
G 1 1/4	1 1/4"	25 – 125	10000	Al	2	PVS3114GPPAENC1	PVS3114GPPAENO1
G 1 1/2	1 1/2"	25 – 125	16000	Al	4.4	PVS3112GPPAENC1	PVS3112GPPAENO1

4-way (5/2)

BSP	dia	psi	lpm	Material	SS	DS	Single solenoid	Double solenoid
* G 1/4	3/16"	25 – 125	700	Al	0.5	0.6	PVS4014G2SA---1	PVS4014G2DA---1
G 3/8	3/8"	25 – 125	2000	Al	1.3	1.3	PVS4038G2SA---1	PVS4038G2DA---1
G 1/2	1/2"	25 – 125	2400	Al	1.2	1.3	PVS4012G2SA---1	PVS4012G2DA---1
G 3/4	3/4"	25 – 125	5500	Al	2.1	2.2	PVS4034G2SA---1	PVS4034G2DA---1
G 1	1"	25 – 125	7000	Al	3.2	3.2	PVS4100G2SA---1	PVS4100G2DA---1
G 1 1/4	1 1/4"	25 – 125	10000	Al	3.8	3.8	PVS4114G2SA---1	PVS4114G2DA---1
G 1 1/2	1 1/2"	25 – 125	16000	Al	4.3	4.4	PVS4112G2SA---1	PVS4112G2DA---1

* G 1/4-5/2 valve is spool type design; SS= single solenoid; DS= double solenoid

• Pilot pressure ≥ Inlet pressure • For pilot-operated valve, put 'P' instead of 'S' in Part Code • For complete details, refer Product Data Sheet.

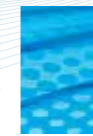

Pneumatic Valves, 4-way, 3-position (Solenoid / pilot operated)



Features

- 5/3 Solenoid and pilot actuated high flow capacity poppet valve
- Sturdy and reliable poppet design
- Port sizes up to G 1 1/2
- Low power solenoid with a range of AC/DC voltages
- Speed up to 600 cycles/min, life up to 10 million cycles
- Manual override as a standard feature
- Material: Body, Piston, Housing- aluminium, Seals- nitrile
- Options: PHN and PRN type in solenoid and pilot version
- Application: Double-acting cylinders and control valves

Available types

PHN Solenoid

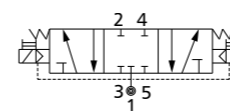

PRN Solenoid

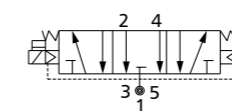

PHN Pilot

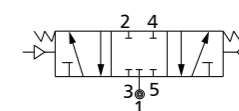

PRN Pilot

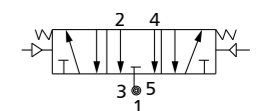

(1-Inlet, 2,4- Outlet, 3,5- Exhaust)

Specifications

Solenoid operated (5/3)

Port Size	Orifice	Pressure	Flow	Material	Weight, kg		Part Code	
					PHN	PRN	PHN	PRN
BSP	dia	psi	lpm					
G 1/4	1/4"	30 – 125	1000	Al	0.7	0.6	PVS4014G3DAPHN1	PVS4014G3DAPRN1
G 3/8	3/8"	30 – 125	2000	Al	1.3	1.4	PVS4038G3DAPHN1	PVS4038G3DAPRN1
G 1/2	1/2"	30 – 125	2400	Al	1.9	1.4	PVS4012G3DAPHN1	PVS4012G3DAPRN1
G 3/4	3/4"	30 – 125	5500	Al	1.9	2.4	PVS4034G3DAPHN1	PVS4034G3DAPRN1
G 1	1"	30 – 125	7000	Al	3.7	3.2	PVS4100G3DAPHN1	PVS4100G3DAPRN1
G 1 1/4	1 1/4"	30 – 125	10000	Al	4.2	4	PVS4114G3DAPHN1	PVS4114G3DAPRN1
G 1 1/2	1 1/2"	30 – 125	16000	Al	4.5	4.5	PVS4112G3DAPHN1	PVS4112G3DAPRN1

Pilot operated (5/3)

BSP	dia	psi	lpm	Material	PHN	PRN	PHN	PRN
G 1/4	1/4"	30 – 125	1000	Al	0.6	0.6	PVPO014G43DPHN1	PVPO014G43DPRN1
G 3/8	3/8"	30 – 125	2000	Al	1.2	1.3	PVPO038G43DPHN1	PVPO038G43DPRN1
G 1/2	1/2"	30 – 125	2400	Al	1.8	1.4	PVPO012G43DPHN1	PVPO012G43DPRN1
G 3/4	3/4"	30 – 125	5500	Al	1.8	2.3	PVPO034G43DPHN1	PVPO034G43DPRN1
G 1	1"	30 – 125	7000	Al	3.5	3	PVPO100G43DPHN1	PVPO100G43DPRN1
G 1 1/4	1 1/4"	30 – 125	10000	Al	4	4	PVPO114G43DPHN1	PVPO114G43DPRN1
G 1 1/2	1 1/2"	30 – 125	16000	Al	4.3	4.3	PVPO112G43DPHN1	PVPO112G43DPRN1

• Pilot pressure ≥ Inlet pressure • For complete details, refer Product Data Sheet.



Pneumatic Valves, stackable series

Features

- 5/2, 5/3 Solenoid actuated stackable type poppet valve
- Internal/external pilot operated poppet design
- Streamlined construction for gang manifold
- Compact size with high flow, improves system appearance and performance
- Mounts in any position
- Continuous duty cycle coil
- Material: Body, Piston, Housing- aluminium, Seals- nitrile
- Options: 3/2, 5/2 and 5/3 types in all sizes



Available types

5/2 Single Solenoid

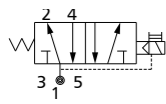

5/2 Double Solenoid

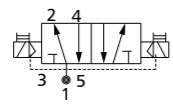

5/3 PHN Solenoid

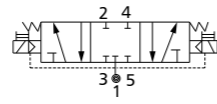

5/3 PRN Solenoid

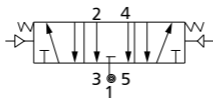

(1- Inlet, 2,4- Outlet, 3,5- Exhaust)

Specifications

3-way (3/2)

Port Size	Orifice	Pressure	Flow	Material	Weight	Part Code	
						Normally closed	Normally open
BSP	dia	psi	lpm		kg		
G 1/8	1/8"	25 – 125	300	Al	0.2	PVSS3018GPPINC1	PVSS3018GPPINO1
G 1/4	1/4"	25 – 125	900	Al	0.4	PVSS3014GPPINC1	PVSS3014GPPINO1
G 3/8	3/8"	25 – 125	2800	Al	1.2	PVSS3038GPPINC1	PVSS3038GPPINO1
G 1/2	1/2"	25 – 125	2800	Al	1.2	PVSS3012GPPINC1	PVSS3012GPPINO1

4-way (5/2)

BSP	dia	psi	lpm	Material	SS	DS	Single solenoid	Double solenoid
G 1/8	1/8"	25 – 125	300	Al	0.17	0.2	PVSS4018G2S---1	PVSS4018G2D---1
G 1/4	1/4"	25 – 125	900	Al	0.4	0.5	PVSS4014G2S---1	PVSS4014G2D---1
G 3/8	3/8"	25 – 125	2800	Al	1.7	1.8	PVSS4038G2S---1	PVSS4038G2D---1
G 1/2	1/2"	25 – 125	2800	Al	1.7	1.8	PVSS4012G2S---1	PVSS4012G2D---1

SS= single solenoid, DS= double solenoid

4-way (5/3)

BSP	dia	psi	lpm	Material	kg	PHN	PRN
G 1/8	1/8"	25 – 125	300	Al	0.2	PVSS4018G3DPHN1	PVSS4018G3DPRN1
G 1/4	1/4"	25 – 125	900	Al	0.5	PVSS4014G3DPHN1	PVSS4014G3DPRN1
G 3/8	3/8"	25 – 125	2800	Al	1.8	PVSS4038G3DPHN1	PVSS4038G3DPRN1
G 1/2	1/2"	25 – 125	2800	Al	1.8	PVSS4012G3DPHN1	PVSS4012G3DPRN1

• For complete details, refer Product Data Sheet.

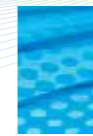

Pneumatic Valves, compact series

Features

- 5/2 Solenoid and pilot actuated spool type compact valve
- Sleek aesthetics with spool type design
- High performance from proven design
- Air spring assisted design for faster response time
- Low power solenoid and manual override as a standard feature
- G 1/4 inlet and cylinder ports
- Facility of gang manifolding
- Options: G 1/8 inlet and cylinder ports, spring-return mushroom button and detent type selector switch, single pilot and double pilot



Available types

5/2 Single Solenoid

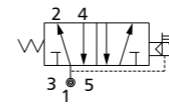

5/2 Double Solenoid

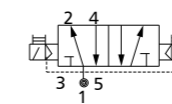

5/2 Single Pilot

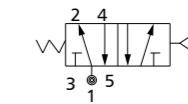

5/2 Selector Switch

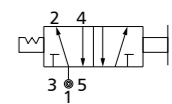

(1- Inlet, 2,4- Outlet, 3,5- Exhaust)

Specifications

4-way (5/2)

Port Size	Orifice	Pressure	Flow	Material	Weight	Type	Part Code
G 1/8	5 mm	25 - 125	600	Al	0.3	Single Solenoid	PVSC4018G2S---1
G 1/8	5 mm	25 - 125	600	Al	0.45	Double Solenoid	PVSC4018G2D---1
G 1/8	5 mm	25 - 125	600	Al	0.3	Single pilot	FPVPOC018G42S---1
G 1/8	5 mm	25 - 125	600	Al	0.4	Double Pilot	FPVPOC018G42D---1
G 1/8	5 mm	25 - 125	600	Al	0.5	Selector Switch	FPVSWC018G42S---1
G 1/8	5 mm	25 - 125	600	Al	0.5	Mushroom button	FPVMBC018G42S---1

G 1/4	6 mm	25 - 125	700	Al	0.3	Single Solenoid	PVSC4014G2S---1
G 1/4	6 mm	25 - 125	700	Al	0.45	Double Solenoid	PVSC4014G2D---1
G 1/4	6 mm	25 - 125	700	Al	0.3	Single pilot	FPVPOC014G42S---1
G 1/4	6 mm	25 - 125	700	Al	0.4	Double Pilot	FPVPOC014G42D---1
G 1/4	6 mm	25 - 125	700	Al	0.5	Selector Switch	FPVSWC014G42S---1
G 1/4	6 mm	25 - 125	700	Al	0.5	Mushroom button	FPVMBC014G42S---1

• For complete details, refer Product Data Sheet.



Pneumatic Valves, manually operated

Features

- 2/2, 3/2, 4/2, 4/3 Manually actuated valves
- Robust design with proven performance
- Mounting provision for individual unit
- Very light operating forces
- Normally open and normally closed models
- Material: Body, Piston- aluminium/brass, Seals- nitrile
- Options: 2/2 NO and NC version in roller and foot pedal



Available types

4/2 Hand Rotary

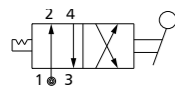

4/3 Hand Rotary

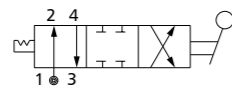

5/2 Hand Lever

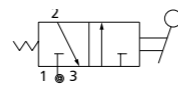

3/2 Roller Operated

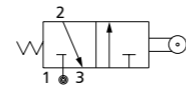

(1- Inlet, 2,4- Outlet, 3,5- Exhaust)

Specifications

Hand rotary valve (4/2 and 4/3)

Port Size	Orifice dia	Pressure psi	Flow lpm	Material	Weight kg		Part Code	
					4/2	4/3	4/2	4/3 PHN
G 1/4	1/4"	0 – 125	1200	Al	1.3	1.6	PVMO014G4RHL2---1	PVMO014G4RHL3PHN1
G 3/8	3/8"	0 – 125	2000	Al	1.3	1.6	PVMO038G4RHL2---1	PVMO038G4RHL3PHN1
G 1/2	3/8"	0 – 125	2000	Al	1.3	3	PVMO012G4RHL2---1	PVMO012G4RHL3PHN1
G 3/4	1/2"	0 – 125	3000	Al	---	3	---	PVMO034G4RHL3PHN1
G1	1"	0 – 125	7000	Al	---	6	---	PVMO100G4RHL3PHN1
G 1 1/2	1 1/4"	0 – 125	10000	Al	---	15	---	PVMO112G4RHL3PHN1

Roller operated valve (3/2)

BSP	dia	psi	lpm	Material	kg	Normally closed	Normally open
G 1/4	1/4"	0 – 125	1000	Al	0.3	PVMO014G3RLR-NC-1	PVMO014G3RLR-NO-1
G 3/8	3/8"	0 – 125	2000	Al	0.5	PVMO038G3RLR-NC-1	PVMO038G3RLR-NO-1
G 1/2	1/2"	0 – 125	2400	Al	0.9	PVMO012G3RLR-NC-1	PVMO012G3RLR-NO-1
G 3/4	3/4"	0 – 125	5500	Al	0.9	PVMO034G3RLR-NC-1	PVMO034G3RLR-NO-1

* 2/2 NO and NC versions available

Foot pedal valve (3/2)

BSP	dia	psi	lpm	Material	kg	Normally closed	Normally open
G 1/4	1/4"	0 – 125	1000	Al	1	PVMO014G3FTP-NC-1	PVMO014G3FTP-NO-1
G 3/8	3/8"	0 – 125	2000	Al	1	PVMO038G3FTP-NC-1	PVMO038G3FTP-NO-1

* 2/2 NO and NC versions available

Hand lever valve (5/2 and 5/3)

BSP	dia	psi	lpm	Material	kg	5/2	5/3PHN
G 1/4	1/4"	0 – 125	1000	Al	0.7	PVMO014GHRL2---1	PVMO014G4HLR3PHN1

• For complete details, refer Product Data Sheet.



Pneumatic Valves, dual sensing

Features

- Optimum poppet technology for high shift consistency
- High flow and dirt tolerant
- Valves supplied with switch reactor
- Application: Used as safety valve in power presses and for clutch/brake controls



Available types

3/2 NC Connected Valve

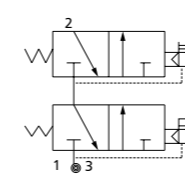

(1- Inlet, 2- Outlet, 3- Exhaust)

Specifications

Port Size	Orifice dia	Pressure psi	Flow lpm	Material	Weight	Part Code
					kg	
G 1/2	1/2"	30 – 125	2400	Al	1.5	PVS3012GDSAINC1
G 3/4	3/4"	30 – 125	5500	Al	3.9	PVS3034GDSAINC1
G 1	1"	30 – 125	7000	Al	4	PVS3100GDSAINC1
G 1 1/2	1 1/2"	30 – 125	16000	Al	9	PVS3112GDSAINC1

• For complete details, refer Product Data Sheet.

Dimensions

(All dimensions in mm)

Basic

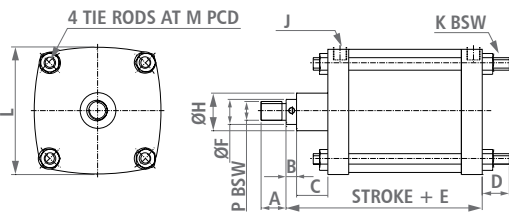

Bore	25	40	50	65	75	100	125	150	200	250	300	350
A	12	19	19	19	19	25	32	32	45	50	50	50
B	8	13	15	15	15	15	19	19	19	19	21	24
C	15	28.5	25	25	32	25	38	38	57	57	60	60
D	20	25	25	25	30	30	40	40	45	45	50	55
*E	78	127	138	141	160	159	215	206	238	247	252	328
F	9.6	19.3	19.3	19.3	19.3	25.6	35.1	35.1	38.1	44.5	50.8	58.4
H	24	38	43	43	47	48	60	60	65	76	86	105
J	G 1/8	G 1/4	G 1/4	G 1/4	G 1/4	G 3/8	G 1/2	G 1/2	G 3/4	G 3/4	G 3/4	G 1
K	3/16"	1/4"	1/4"	1/4"	3/8"	3/8"	1/2"	1/2"	3/4"	3/4"	1"	1"
L	38	50.5	63.5	77.5	92	119	146	170	225	278	330	390
M	35.5	54	68	83	99	125	152.5	179	241.5	294	351	400
P	M8	1/2"	1/2"	1/2"	1/2"	3/4"	1"	1"	1 1/4"	1 1/2"	1 3/4"	1 3/4"

* Stroke length above 1000 mm offered with stop tube

Double-ended and stroke adjustable cylinder

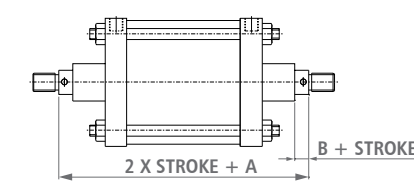

Bore	A	B	C	D	E	H
25	101	8	15	—	—	—
40	168.5	13	28.5	14	10	38
50	178	15	25	14	10	38
65	181	15	25	14	10	38
75	207	15	32	14	10	38
100	199	15	25	20	10	45
125	272	19	38	25	10	55
150	263	19	38	25	10	55
200	314	19	57	30	10	60
250	323	19	57	35	10	70
300	333	21	60	40	10	75
350	412	24	60	50	10	90

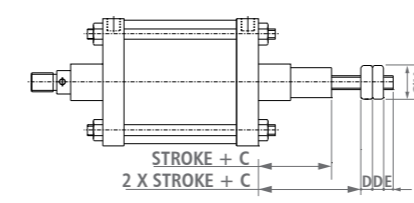
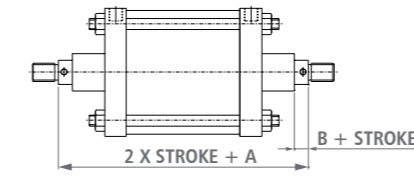

Front and rear flange mounting



Bore	25	40	50	65	75	100	125	150	200	250	300	350
A	8	9.5	9.5	9.5	12.5	12.5	13	13	19	19	25.5	30
B	70	95	108	121	152	178	203	228	324	384	451	515
C	55	73	86	98.5	120.5	146	168	190	268	323	401	455
D	38	50.5	64	77	92	120	146	170	222	273	325	375
E	25	28.5	42	54	63.5	89	118	133.5	159	216	254	265
F	5	10	10	10	13.5	13.5	13.5	13.5	20	20	26	26

Cylinder accessories

Rod fork

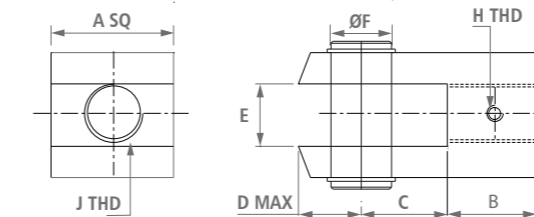

Standard pneumatic cylinder

Bore	A	B	C	D	E	F	H	J
25	18	12	13	12	10	8	M4	M8
40	28	20	19	16	15	10	M6	1/2" BSW
50, 65	28	20	20	19	15	12	M6	1/2" BSW
75	35	20	22	24	17	16	M6	1/2" BSW
100	45	26	28	30	25	19	M6	3/4" BSW
125, 150	54	32	32	40	30	25.4	M8	1" BSW
200	64	45	36	50	32	31.8	M8	1 1/4" BSW
250	76	50	45	55	40	38.1	M8	1 1/2" BSW
300, 350	90	50	52	60	50	40	M8	1 3/4" BSW

Rear trunnion and rear eye mounting

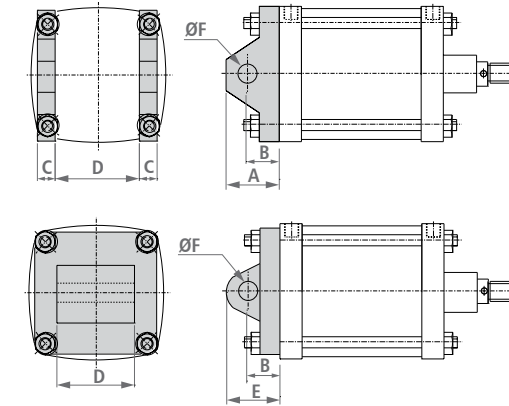

Bore	25	40	50	65	75	100	125	150	200	250	300	350
A	—	32	35	38	48	54	70	70	89	102	121	125
B	15.5	21	22.5	24.5	32	38	44	44	54	57	77	80
C	—	10	10	10	16	16	21	21	32	32	38	40
D	12	28	38	48.6	54	72.4	86.8	105.5	138.8	176	210.2	242.8
E	28	31	35	40.5	51	57	70	70	86	95	115	120
F	9.5	9.5	12.7	16	19	19	25.4	25.4	31.8	38.1	38.1	40

Hinge mounting

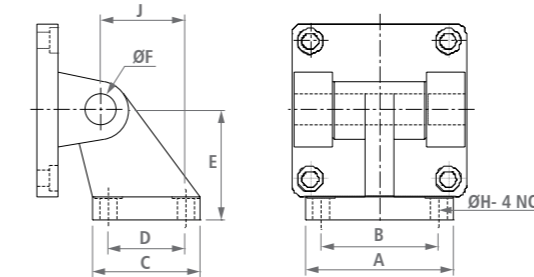

Standard pneumatic cylinder

Bore	A	B	C	D	E	F	H	J
40	54	41	35	22	36	9.5	6.6	24
50	65	50	45	30	45	12.7	9	33
65	67	52	50	35	50	16	9	37
75	86	66	60	40	63	19	11	47
100	96	76	70	50	71	19	11	55
125	124	94	90	60	90	25.4	14	70
150	148	118	118	88	115	25.4	16	97
200	162	122	130	90	135	31.8	16	105
250	200	150	160	110	165	38.1	22	128
300	230	170	182	122	200	38.1	27	150
350	260	200	210	150	225	40	27	175

Foot and centre trunnion mounting

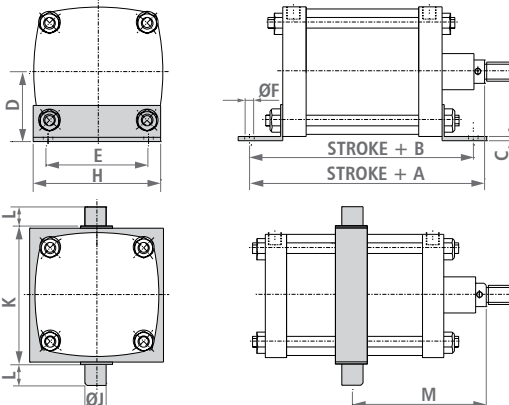

Bore	25	40	50	65	75	100	125	150	200	250	300	350
A	92	148.5	163	166	197	197	257	248	296	305	322	398
B	83	128.5	148	151	187	195	242	233	278	287	311	384
C	3	3.5	3.5	5	6	6	6	6	8	8	10	10
D	26.5	33	36.8	42.3	57	66.7	79	88	120.4	140	168.5	210
E	25	50	38	56.5	66	95	114.5	141	176	202	266	315
F	5	7	10	10	13.5	13.5	13.5	13.5	20	20	26	26
H	38	63	62.5	77	92	121	146	171	222	265	324	375
J	8	10	12	16	19	25.4	31.8	31.8	38.1	44.5	50.8	57
K	42	60	76	92	108	136	164	191	251	311	371	426
L	10	12	12	16	19	25	32	32	38	40	45	50
M	Customer to specify											

• For complete details, refer Product Data Sheet.



ISO Pneumatic Cylinders (Series M)



Features

- Cylinders with nylon end covers, nylon piston and 'Mickey Mouse' profile aluminum tube
- Light weight with high strength
- Dimensions as per ISO 6431
- Stroke length offered up to 2500 mm
- Fully adjustable cushioning at both ends
- Options: Bellows, hollow shaft, rod extension and rod threading
- Specials: Reed switch, single-acting, stroke adjustable, double-ended and duplex
- Ideal for use in most demanding automation applications

Available types

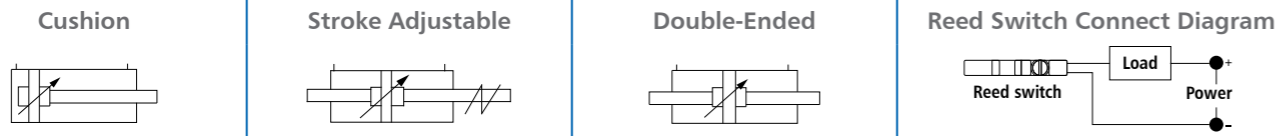

Specifications

Bore sizes	32, 40, 50, 63, 80, 100, 125 mm
Medium	Compressed air (filtered and lubricated)
Design	Piston cylinder with cushion/non-cushion version
Pressure range	7 to 150 psi (0.5 to 10 bar)
Temperature range	-10 °C to 60 °C
Construction	End covers- nylon, aluminium (optional), Tube- 'Mickey Mouse' profile aluminium semi-hard anodised, Piston rod- EN-8 hard chrome plated, stainless steel (optional), Piston- nylon, aluminium (optional), Mountings- mild steel/cast iron, Seals- NBR

Ordering code

FPC | **I** | **A** | **A** | **1** | **100** | **G** | **0250** | **X** | **X** | **X**

I ISO | A 150 psi | 1 Cushion | 2 Non-cushion | G Ram size (C 12, D 16, F 20, G 25, J 36) | X Type 1 (Standard, Stroke adjustable, Double ended, Duplex, Single acting) | X Type 2 (Std. metric, Female metric, Hollow male, Hollow female) | X Type 3 (Standard, Rod extension, Special, Piston with magnet)

Mountings		Bore size	
A	Front flange	32	125
B	Rear flange	40	
C	Rear eye	50	
D	Rear clevis	63	
E	Intermediate trunnion	80	
F	Centre trunnion	100	
G	Foot		
I	Stud		
J	Neck		
K	Basic		

• Reed switch to be order separately, Part no. EP-39R-25M

Dimensions

(All dimensions in mm)

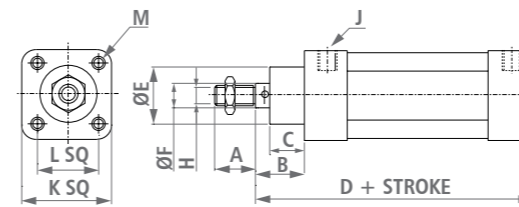

Basic

Bore	32	40	50	63	80	100	125
A	22	24	32	32	40	40	54
B	24	29.5	34.5	34.5	42.5	47.5	58
C	18	19.5	19.5	19.5	27.5	32.5	38
*D	122	135.5	145.5	160.5	177.5	192.5	232
E	30	36	43	43	48	48	60
F	12	16	20	20	25	25	36
H	M10X1.25	M12X1.25	M16X1.5	M16X1.5	M20X1.5	M20X1.5	M27X2
J	G 1/8	G 1/4	G 1/4	G 3/8	G 3/8	G 1/2	G 1/2
K	47	55	66	76	97	114	137
L	32.5	38	46.5	56.5	72	89	110
M	M6X1	M6X1	M8X 1.25	M8X 1.25	M10X1.5	M10X1.5	M12X1.75

* Stroke length above 1000 mm offered with stop tube

Front and rear flange mounting

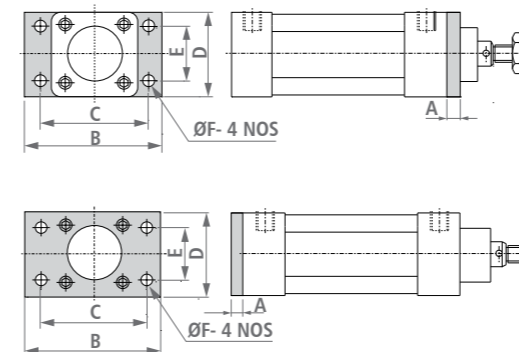

Bore	32	40	50	63	80	100	125
A	8	9.5	9.5	9.5	12.5	12.5	13
B	81	95	108	120	152	178	215
C	64	72	90	100	126	150	180
D	47	55	66	76	97	114	137
E	32	36	45	50	63	75	90
F	7	9	9	9	12	14	16

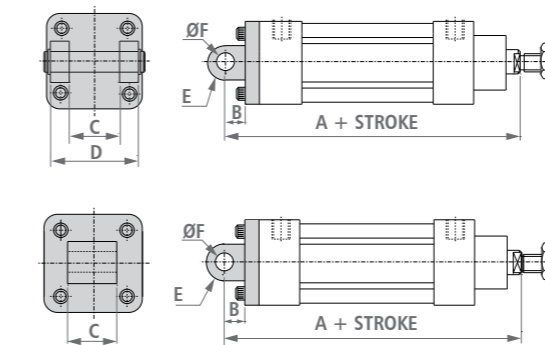

Bore	32	40	50	63	80	100	125
A	142	160	170	190	210	230	275
B	12	15	15	20	20	25	30
C	26	28	32	40	50	60	70
D	45	52	60	70	90	110	130
E	R10	R12	R12	R16	R16	R20	R25
F	10	12	12	16	16	20	25

Foot and centre trunnion mounting

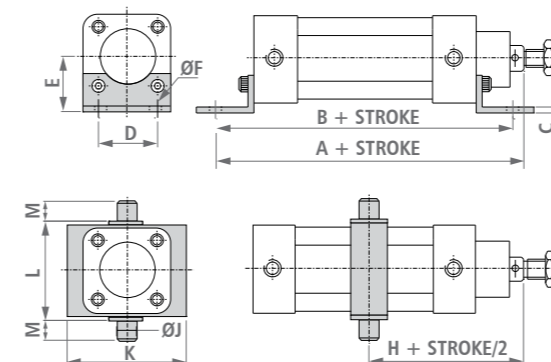

Bore	32	40	50	63	80	100	125
A	144	163	175	190	215	230	270
B	142	161	170	185	210	220	250
C	3	3.5	3.5	5	7	7	7
D	32	36	45	50	63	75	90
E	32	36	45	50	63	71	90
F	7	9	9	9	12	14	16
H	73	82.5	90	97.5	110	120	145
J	12	16	16	20	20	25	25
K	65	75	95	105	130	145	175
L	50	63	75	90	110	132	160
M	12	16	16	20	20	25	25

• For complete details, refer Product Data Sheet.



ISO Pneumatic Cylinders (Series S)



- Cylinders with aluminum casting end covers, aluminum casting piston and 'Square' profile aluminum tube
- High performance cylinders for modern demands
- Polyurethane seal ensures long life and high speed
- Dimensions as per ISO 15552, VDMA 24562
- Modern type injection moulded reed switch
- 3 psi minimum pressure to move cylinder
- Options: Bellows, viton seals, hollow shaft, rod extension and rod threading
- Specials: Reed switch, single-acting, stroke adjustable, double-ended and duplex

Available types

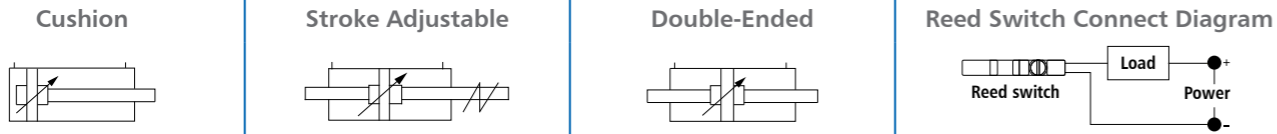

Specifications

Bore sizes	32, 40, 50, 63, 80, 100, 125 mm
Medium	Compressed air (filtered and lubricated)
Design	Piston cylinder with magnetic and non magnetic version
Pressure range	7 to 150 psi (0.5 to 10 bar)
Temperature range	-10 °C to 60 °C, up to 150 °C with viton seals
Construction	End covers- aluminium, Tube- 'Square' profile aluminium semi-hard anodised, Piston rod- EN-8 hard chrome plated, stainless steel (optional), Piston- aluminium, Mountings- mild steel/cast iron, Seals- NBR, polyurethane

Ordering code

FPC N A C 1 80 G 0125 X X M

N ISO New
Pressure A 150 psi
1 Cushion
Stroke
Ram size
Type 1
Type 2
Type 3
Bore size
Mountings

A	Front flange	G	Foot
B	Rear flange	I	Stud
C	Rear eye	J	Neck
D	Rear clevis	K	Basic
E	Intermediate trunnion		
F	Centre trunnion		

C	12
D	16
F	20
G	25
P	32

X	Standard	X	Std. (metric)	M	Standard with magnet
1	Stroke adjustable	3	Female metric	9	Rod extension
2	Double ended	4	Hollow male	0	Special
4	Duplex	5	Hollow female		
5	Single acting	6	Viton Seal		

32	125
40	
50	
63	
80	
100	

• Reed switch to be order separately, Part no. EP-39R-25M

Dimensions

(All dimensions in mm)

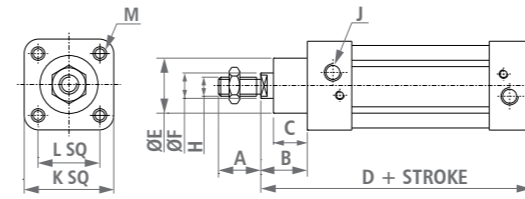

Basic

Bore	32	40	50	63	80	100	125
A	22	24	32	32	40	40	54
B	26	30	37	37	48	51	65
C	16	20	27	27	32	33	45
*D	120	135	143	158	174	189	225
E	30	35	40	45	45	55	60
F	12	16	20	20	25	25	32
H	M10X1.25	M12X1.25	M16X1.5	M16X1.5	M20X1.5	M20X1.5	M27X2
J	G 1/8	G 1/4	G 1/4	G 3/8	G 3/8	G 1/2	G 1/2
K	47	53.5	63.5	75	95	113	140
L	32.5	38	46.5	56.5	72	89	110
M	M6X1	M6X1	M8X1.25	M8X1.25	M10X1.5	M10X1.5	M12X1.75

* Stroke length above 1000 mm offered with stop tube

Front and rear flange mounting

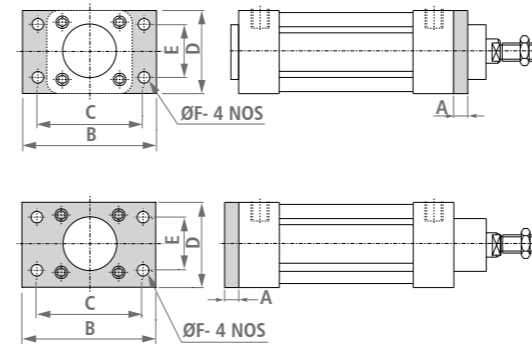

Bore	32	40	50	63	80	100	125
A	10	10	12	12	16	16	20
B	80	90	110	120	150	170	224
C	64	72	90	100	126	150	180
D	46	54	64	75	95	112	140
E	32	36	45	50	63	75	90
F	7	9	9	9	12	14	16

Rear clevis and rear eye mounting

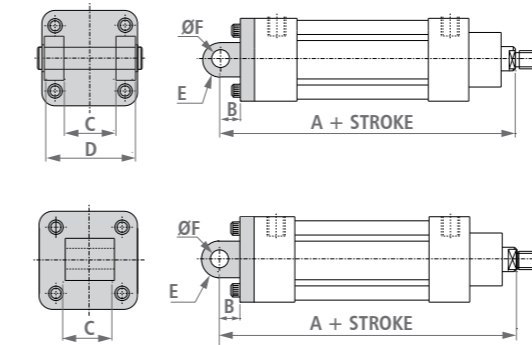

Bore	32	40	50	63	80	100	125
A	142	160	170	190	210	230	275
B	14	15	16	20	22	27	31
C	26	28	32	40	50	60	70
D	45	52	60	70	90	110	130
E	R 10	R 13	R 13	R 17	R 17	R 20	R 25
F	10	12	12	16	16	20	25

Foot and centre trunnion mounting

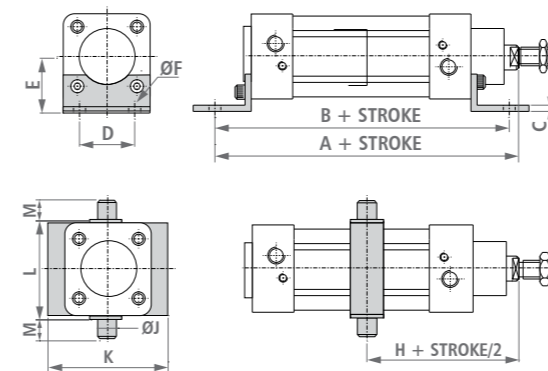

Bore	32	40	50	63	80	100	125
A	144	163	175	190	215	230	270
B	142	161	170	185	210	220	250
C	3	3.5	3.5	5	7	7	7
D	32	36	45	50	63	75	90
E	32	36	45	50	63	71	90
F	7	9	9	9	12	14	16
H	73	82.5	90	97.5	110	120	-
J	12	16	16	20	20	25	-
K	65	75	95	105	130	145	-
L	50	63	75	90	110	132	-
M	12	16	16	20	20	25	-

• For complete details, refer Product Data Sheet.



ISO Pneumatic Cylinders (Series R)



Features

- Cylinders with aluminum casting end covers, aluminum casting piston and 'Round' profile aluminum tube
- High performance cylinders for modern demands
- Dimensions as per ISO 15552, VDMA 24562
- Polyurethane seals for long life and high speed
- Injection moulded reed switch with aluminium bracket
- 3 psi minimum pressure to move cylinder
- Options: Bellow, viton seals, hollow shaft, rod extension and rod threading
- Specials: Reed switch, single-acting, stroke adjustable, double-ended and duplex

Available types

Cushion



Stroke Adjustable

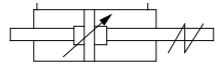

Double-Ended

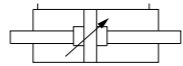

Reed Switch Connect Diagram

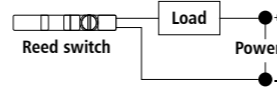

Specifications

Bore sizes	32, 40, 50, 63, 80, 100, 125, 160, 200 mm
Medium	Compressed air (filtered and lubricated)
Design	Piston cylinder with magnetic and non magnetic version
Pressure range	7 to 150 psi (0.5 to 10 bar)
Temperature range	-10 °C to 60 °C, up to 150 °C with viton seals
Construction	End covers- aluminium, Tube- round profile aluminium semi-hard anodised, Piston rod- EN-8 hard chrome plated, stainless steel (optional), Piston- aluminium, Mountings- mild steel/cast iron, Seals- NBR, polyurethane

Ordering code

FPC R A C 1 80 G 0125 X X M

R ISO New

1 Cushion

Mountings		Bore size	
A	Front flange	F	Centre trunnion
B	Rear flange	G	Foot
C	Rear eye	I	Stud
D	Rear clevis	J	Neck
E	Intermediate trunnion	K	Basic

Type 1	Type 2	Type 3
X Standard	X Std. (metric)	M Standard with magnet (up to bore Ø 125 mm)
1 Stroke-adjustable	3 Female metric	
2 Double-ended	4 Hollow male	
4 Duplex	5 Hollow female	9 Rod extension
5 Single-acting	6 Viton seal	0 Special

• Reed switch to be ordered separately, Part no. EP-39R-25M

Dimensions

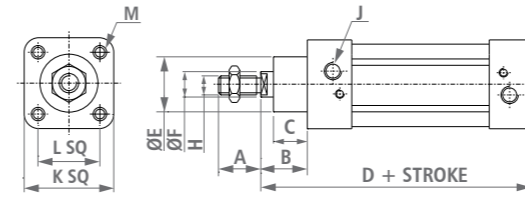

Basic

Bore	32	40	50	63	80	100	125
A	22	24	32	32	40	40	54
B	26	30	37	37	48	51	65
C	16	20	27	27	32	33	45
*D	120	135	143	158	174	189	225
E	30	35	40	45	45	55	60
F	12	16	20	20	25	25	32
H	M10X1.25	M12X1.25	M16X1.5	M16X1.5	M20X1.5	M20X1.5	M27X2
J	G 1/8	G 1/4	G 1/4	G 3/8	G 3/8	G 1/2	G 1/2
K	47	53.5	63.5	75	95	113	140
L	32.5	38	46.5	56.5	72	89	110
M	M6X1	M6X1	M8X1.25	M8X1.25	M10X1.5	M10X1.5	M12X1.75

* Stroke length above 1000 mm offered with stop tube

Front and rear flange mounting

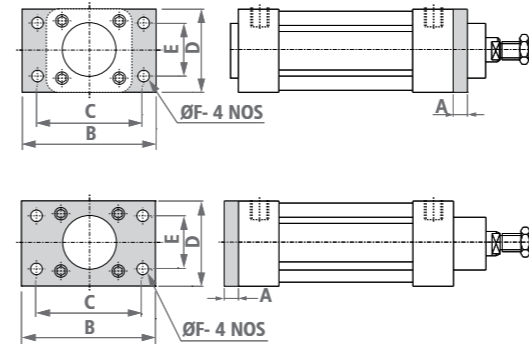

Bore	32	40	50	63	80	100	125
A	10	10	12	12	16	16	20
B	80	90	110	120	150	170	224
C	64	72	90	100	126	150	180
D	46	54	64	75	95	112	140
E	32	36	45	50	63	75	90
F	7	9	9	9	12	14	16

Rear clevis and rear eye mounting

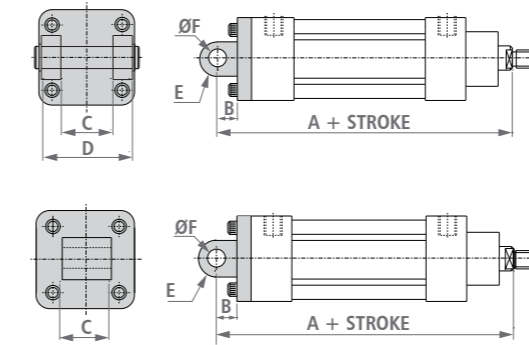

Bore	32	40	50	63	80	100	125
A	142	160	170	190	210	230	275
B	14	15	16	20	22	27	31
C	26	28	32	40	50	60	70
D	45	52	60	70	90	110	130
E	R 10	R 13	R 13	R 17	R 17	R 20	R 25
F	10	12	12	16	16	20	25

Foot and centre trunnion mounting

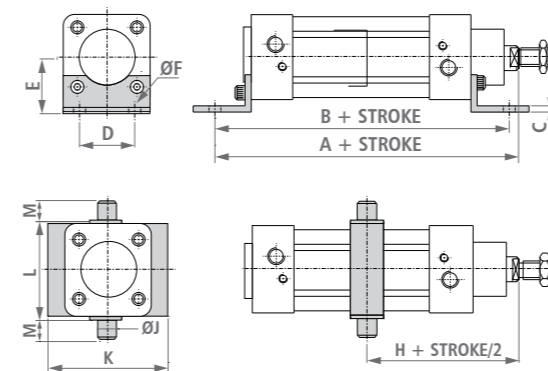

Bore	32	40	50	63	80	100	125
A	144	163	175	190	215	230	270
B	142	161	170	185	210	220	250
C	3	3.5	3.5	5	7	7	7
D	32	36	45	50	63	75	90
E	32	36	45	50	63	71	90
F	7	9	9	9	12	14	16
H	73	82.5	90	97.5	110	120	145
J	12	16	16	20	20	25	25
K	65	75	95	105	130	145	175
L	50	63	75	90	110	132	160
M	12	16	16	20	20	25	25

Dimensions

(All dimensions in mm)

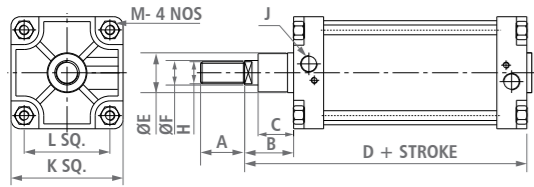

Basic

Bore	160	200
A	72	72
B	80	95
C	58	67
*D	260	275
E	65	75
F	40	40
H	M36x2	M36x2
J	G 3/4	G 3/4
K	183	220
L	140	175
M	M16X2	M16X2

* Stroke length above 1000 mm offered with stop tube

Rod fork

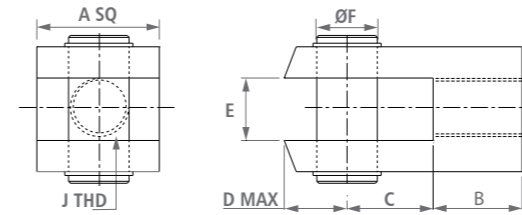

ISO Pneumatic Cylinders (Series M, R and S)

Bore	A	B	C	D	E	F	J
32	20	20	20	16	10.2	10	M10X1.25
40	24	24	24	19	12.2	12	M12X1.25
50, 63	30	34	32	25	16.2	16	M16X1.5
80, 100	38	40	40	32	20.2	20	M20X1.5
125	55	55	55	45	30	30	M27X2
160,200	70	72	72	53	35	35	M36X2

* Rod yoke type, rod end aligner and rod end spherical eye is also available

Hinge mounting

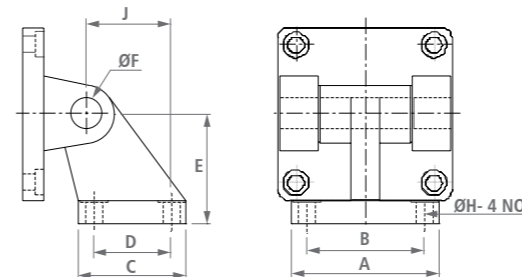

ISO Pneumatic Cylinders (Series M, R and S)

Bore	A	B	C	D	E	F	J	H
32	51	38	31	18	32	10	6.6	21
40	54	41	45	22	36	12	6.6	24
50	65	50	45	30	45	12	9	33
63	67	52	50	35	50	16	9	37
80	86	66	60	40	63	16	11	47
100	96	76	70	50	71	20	11	55
125	124	94	90	60	90	25	14	70

Front and rear flange mounting

Bore	160	200
A	22	25
B	280	320
C	230	270
D	180	220
E	115	135
F	18	22

Thrust chart

Bore size (mm)		Air Pressure									Free Air Consumption in 1/25 mm stroke @ 7 bar
		2 bar	3 bar	4 bar	5 bar	6 bar	7 bar	8 bar	9 bar	10 bar	
32	PUSH	13	19	26	32	39	45	52	58	64	0.16
	PULL	10	17	22	28	33	39	44	50	55	
40	PUSH	20	30	40	50	60	70	80	90	100	0.25
	PULL	17	26	35	44	52	61	70	76	87	
50	PUSH	32	47	63	78	94	110	125	141	157	0.39
	PULL	27	41	54	68	82	96	109	123	137	
63	PUSH	50	75	100	124	149	174	199	224	249	0.62
	PULL	44	66	87	109	131	153	175	197	218	
80	PUSH	88	121	161	201	241	281	321	361	402	1.00
	PULL	74	111	149	185	223	260	297	334	371	
100	PUSH	126	188	251	314	377	440	502	565	628	1.57
	PULL	113	169	232	288	345	401	464	526	590	
125	PUSH	210	330	435	545	650	770	870	990	1100	2.5
	PULL	200	310	410	500	600	720	820	920	1000	
160	PUSH	350	530	720	900	1025	1250	1430	1600	1800	4.0
	PULL	330	508	675	840	950	1175	1350	1500	1700	
200	PUSH	550	840	1120	1400	1600	1950	2250	2500	2800	6.4
	PULL	535	810	1000	1345	1525	1900	2150	2400	2700	

NOTE • The above thrust chart determines practical thrusts.
• Select force required by reading down from selected working pressure.

• Select working pressure on top of chart.
• Read out cylinder bore size on left of the chart.

• For complete details, refer Product Data Sheet.

Rear clevis and rear eye mounting

Bore	160	200
A	315	335
B	35	36
C	90	90
D	170	170
E	30	30
F	30	30

Foot and centre trunnion mounting

Bore	160	200
A	320	345
B	300	320
C	10	12
D	115	135
E	115	135
F	18.5	24
H	170	185
J	32	32
K	195	248
L	200	250
M	32	32



ISO Compact Pneumatic Cylinders

Features

- Space saving, compact and light weight design
- Dimensions as per ISO 21287
- Low friction, long life seals
- Large clamping force in relation to size
- Standard t-slot for magnetic reed switch
- Magnetic sensor common for all sizes
- Options: Male and female piston rod threading, foot and flange mountings, viton seals
- Specials: Single-acting and double ended
- Available mountings to suit leading international brands



Dimensions

(All dimensions in mm)

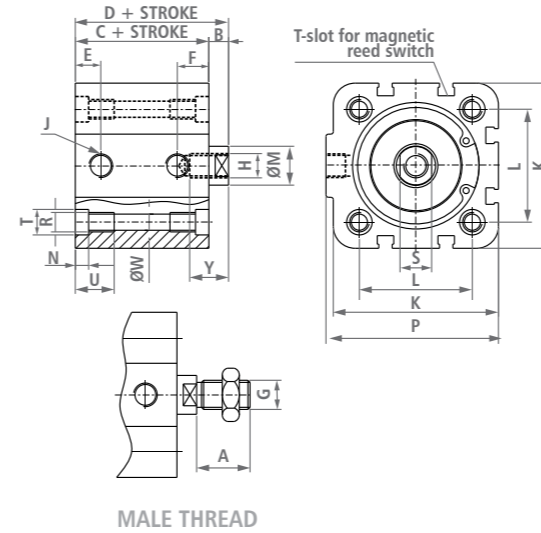

Bore	25	32	40	50	63	80	100
A	16	19	19	22	22	28	28
B	6	7	7	8	8	10	10
C	39	44	45	45	49	54	67
D	45	51	52	53	57	64	77
E	10	12	12	12	14	16	20
F	10	13	13	13	14	15.5	20
G	M8x1.25	M10x1.25	M10x1.25	M12x1.25	M12x1.25	M16x1.5	M16x1.5
H	M6x1	M8x1.25	M8x1.25	M10x1.5	M10x1.5	M12x1.75	M12x1.75
J	M5	G 1/8	G 1/8	G 1/8	G 1/8	G 1/8	G 1/8
K	40.5	45	60	68	80	98	114.5
L	26	32.5	38	46.5	56.5	72	89
M	10	12	12	16	16	20	20
N	5.0	5.5	5.5	5.5	5.5	5.5	5.5
P	43	49.5	62.5	71	88	104.5	123.5
R	M5	M6	M6	M8	M8	M10	M10
S	9	10	10	13	13	17	17
T	7.5	9	9	11	11	14	14
U	15	15	15	16	16	17	17
W	4.2	5.1	5.1	6.5	6.5	8.5	8.5
Y	10	12	12	16	16	20	20

* Stroke length offered up to max. 75 mm for all bore sizes

Available types

Single-Ended

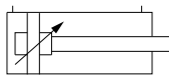

Double-Ended

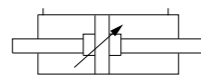

Single-Acting

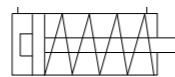

Reed Switch Connect Diagram

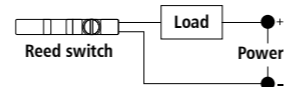

Specifications

Bore Sizes	16, 20, 25, 32, 40, 50, 63, 80, 100 mm
Medium	Compressed air (filtered and lubricated)
Design	Piston cylinder with cushion pad, magnetic and non magnetic version
Pressure range	7 to 150 psi (0.5 to 10 bar)
Temperature range	5 °C to 60 °C, up to 150 °C with viton seals (optional)
Material	End covers and piston- aluminium, Tube- square profile aluminium anodised, Piston rod- EN-8 hard chrome plated, Mountings: mild steel, Seals- NBR, polyurethane

Ordering code

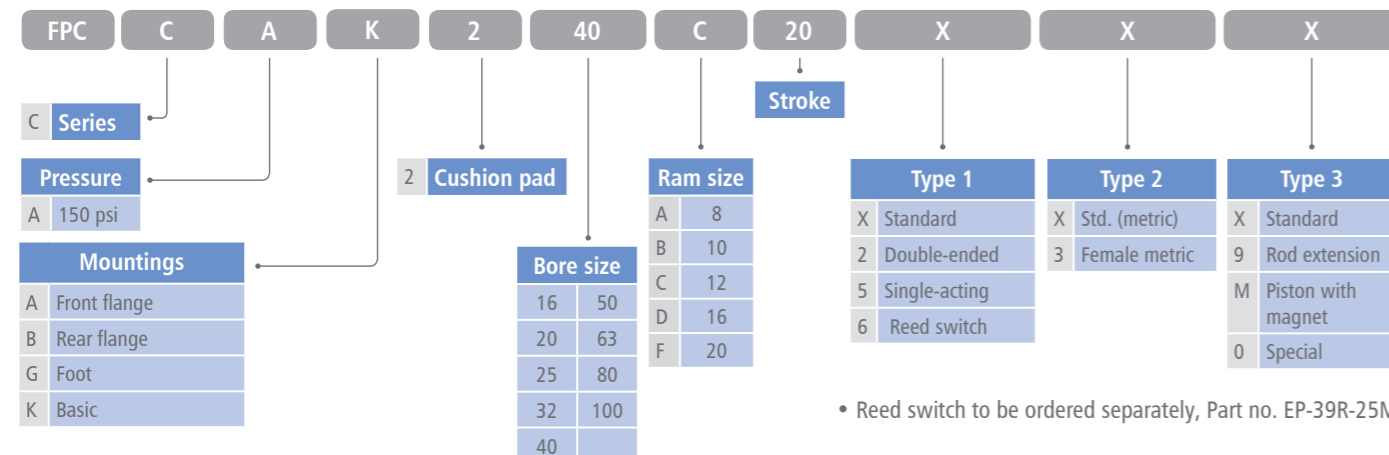

• Reed switch to be ordered separately, Part no. EP-39R-25M

Front and rear flange mounting

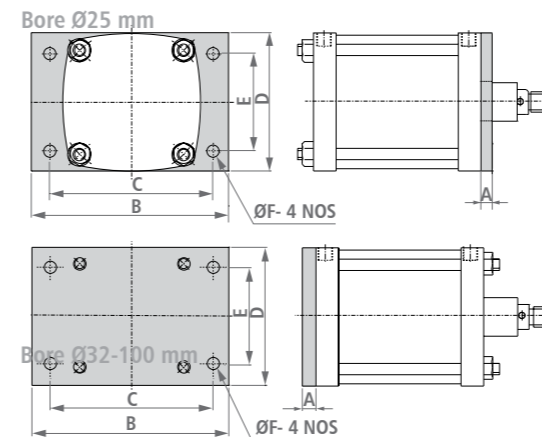

Bore	25	32	40	50	63	80	100
A	8	10	10	12	12	16	16
B	76	80	90	110	125	155	185
C	60	64	72	90	100	126	150
D	40	50	55	68	78	100	120
E	-	32	36	45	50	63	75
F	6.5	7	9	9	9	12	14
H	53	61	62	65	69	80	93

Foot mounting

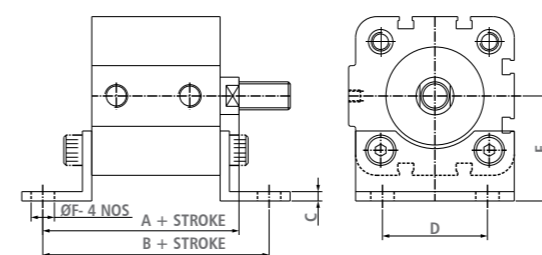

Bore	25	32	40	50	63	80	100
A	61	67	70	74	78	90	104
B	71	76	81	87	91	106	121
C	4	4	4	5	5	6	6
D	26	32	36	45	50	63	75
E	29	33.5	38	45	50	63	74
F	7	7	10	10	10	12	15

• For complete details, refer Product Data Sheet.



Air-Line Accessories

Features

- Rugged and durable design
- Works up to 10 bar pressure
- Used to perform supportive pneumatic functions
- Variety
 - Flow control valves with fine regulation
 - Quick exhaust valves for higher cylinder speeds
 - Inline check valves with low closing pressure
 - High pressure (20 bar) inline check valves
 - Rotor seal coupling in sizes up to G 1 1/2
 - Inline mounted hand slide valves
- Silencers
- Air blow guns



Port Size BSP	Flow lpm	Part Code
------------------	-------------	-----------

Inline Flow Control Valve

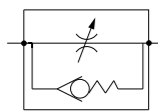

G 1/4	1000	PVFC014G1
G 1/2	2000	PVFC012G1
G 3/4	4000	PVFC034G1

Port Size BSP	Flow lpm	Part Code
------------------	-------------	-----------

Flow Control Valve

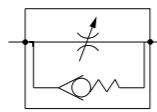

G 1/4	650	PVFC014G2
G 1/2	1800	PVFC012G2
G 3/4	3000	PVFC034G2

Port Size BSP	Flow lpm	Part Code
------------------	-------------	-----------

Needle Valve

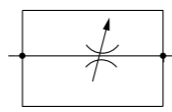

G 1/4	1000	PVNL014G1
G 1/2	2000	PVNL012G1
G 3/4	4000	PVNL034G1

Quick Exhaust Valve

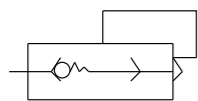

G 1/4	1500	PVQE014G1
G 3/8	2500	PVQE038G1
G 1/2	4500	PVQE012G1
G 3/4	8000	PVQE034G1
G 1	10000	PVQE100G1
G 1 1/2	12000	PVQE112G1

Shuttle Valve

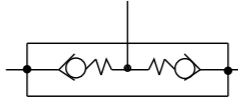

G 1/4	1100	FPVS014G1
G 3/8	2500	FPVS038G1
G 1/2	4200	FPVS012G1
G 3/4	5500	FPVS034G1
G 1	7000	FPVS100G1

Inline Check Valve

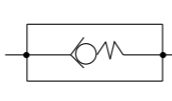

G 1/4	1000	PVNR014GA1251
G 3/8	2800	PVNR038GA1251
G 1/2	4500	PVNR012GA1251
G 3/4	8000	PVNR034GA1251
G 1	10000	PVNR100GA1251

Rotor Seal Coupling

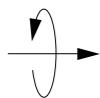

G 1/4	PVRS014GAARRH1
G 3/8	PVRS038GAARRH1
G 1/2	PVRS012GAARRH1
G 3/4	PVRS034GAARRH1
G 1	PVRS100GAARRH1
G 1 1/4	PVRS114GAARRH1
G 1 1/2	PVRS112GAARRH1

Silencer



G 1/4	PVS014G1
G 3/8	PVS038G1
G 1/2	PVS012G1
G 3/4	PVS034G1
G 1	PVS100G1
G 1 1/4	PVS114G1
G 1 1/2	PVS112G1

Hand Slide Valve

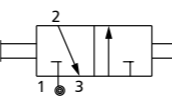

G 1/4	1000	PVHS014G1
G 3/8	2800	PVHS038G1
G 1/2	4000	PVHS012G1
G 3/4	8000	PVHS034G1

- LH, RH threading and stainless steel shaft also available for Rotor seal coupling.
- For complete details, refer Product Data Sheet.



Air Preparation Units

Features

- Modular style, pre-assembled, ready to install
- Suitable for wall mounting
- Bronze type filtering element
- Relieving type diaphragm operated regulator
- Non-rising adjusting knob with snap action lock
- Good flow and regulating characteristics
- Fine adjustment of lubrication
- Quick release bayonet bowl



Available types

Filter



Regulator



Lubricator



Filter, Regulator, Lubricator

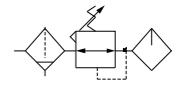

Specifications

Port Size	G 1/8	G 1/4	G 3/8	G 1/2	G 3/4	G 1
Flow rate (lpm)	500	2000	4000	4000	5000	5000
Fluid (media)	Compressed air					
Pressure	Operating: 0.5 to 10 bar, Proof: 15 bar					
Temperature range	5 °C to 60 °C					
Filter material	Sintered bronze, plastic (polypropylene)					
Filter rating	Standard: 25 µm, Optional: 5 µm					
Oil recommended	Turbine oil (ISO VG 32)					
Bowl material	Polycarbonate bowl with metal guard					
Regulator construction	Relieving, diaphragm type					
Drain type	Differential (semi-automatic) and automatic					

Ordering code

Filter	EPF-200-18	EPF-300-14	EPF-400-38	EPF-400-12	EPF-500-34	EPF-500-01
Regulator	EPR-200-18	EPR-300-14	EPR-400-38	EPR-400-12	EPR-500-34	EPR-500-01
Lubricator	EPL-200-18	EPL-300-14	EPL-400-38	EPL-400-12	EPL-500-34	EPL-500-01
Filter, Regulator	EPM-200-18	EPM-300-14	EPM-400-38	EPM-400-12	EPM-500-34	EPM-500-01
Filter, Regulator and Lubricator	EPC-200-18	EPC-300-14	EPC-400-38	EPC-400-12	EPC-500-34	EPC-500-01
Filter, Regulator, Lubricator	EPU-200-18	EPU-300-14	EPU-400-38	EPU-400-12	EPU-500-34	EPU-500-01

- For complete details, refer Product Data Sheet.



Standard Hydraulic Cylinders



Features

- Cylinders with M.S. end covers and 'Round' profile M.S. honed tube
- Long established design, proven ruggedness and reliability
- PTFE seals and bearing strips ensure perfect sealing and smooth movement
- Externally removable bolt-on cartridge assembly
- Stroke length offered up to 3500 mm
- Working pressure up to 200 bar
- Options: Bellows, rod extension and rod threading
- Specials: Bore above dia. 300 mm, LVDT, double-ended, stroke adjustable, large ports, working pressure up to 345 bar

Dimensions

(All dimensions in mm)

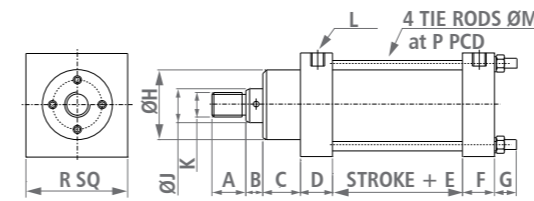

Basic

Bore	40	50	65	75	100	125	150
A	26	26	32	50	50	50	64
B	16	16	19	26	26	26	30
C	47	47	47	61	60	60	60
D	32	35	41	42	52	52	53
*E	65	65	77	85	92	102	107
F	24	26	32	32	45	45	45
G	32	33	33	37	42	46	46
H	68	68	77	100	115	115	146
J	25.6	25.6	35.1	45.8	58.4	58.4	85.8
K	M20X2.5	M20X2.5	M24X3	M33X3.5	M45X4.5	M45X4.5	M70X3
L	G 1/4	G 3/8	G 1/2	G 1/2	G 3/4	G 3/4	G 3/4
M	8	10	10	12	20	24	24
P	60	77	88	105	141.5	178	204
R	69	74	82	102	140	175	198

* Stroke length above 1000 mm offered with stop tube.

Available types

Non-Cushion

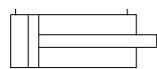

Cushion



Stroke Adjustable

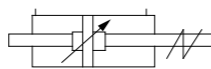

Double-Ended

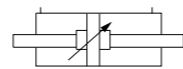

Specifications

Bore sizes	40, 50, 65, 75, 100, 125, 150, 200, 250, 300 mm
Medium	Mineral oil (ISO VG 68)
Design	Piston cylinder with cushion/non-cushion version
Pressure range	Up to 3000 psi (200 bar), 345 bar on request
Temperature range	-10 °C to 60 °C, up to 150 °C with viton seals
Construction	End covers- mild steel, Tube- mild steel seamless honed, Piston rod- EN-8 hard chrome plated, stainless steel (optional), Piston- mild steel, Mountings- mild steel/cast iron, Seals- PTFE, NBR

Ordering code

FHC S A A 1 150 G 0450 X X X

Option	Value
J	Jack
S	Standard
I	Intensifier
C	Swing clamp
Pressure	A 3000 psi, B 5000 psi
1	Front cushion
2	Rear cushion
3	Both cushion
4	Non cushion
Ram size	A 25.6, B 35.1, C 45.8, D 50.8, E 58.4, F 74.6, G 85.8, H 103, I 130.5, J 181.5
Stroke	0450
Type 1	Standard
1	Stroke adjustable
2	Double ended
3	Large Port
Type 2	X Std. (metric), 1 Female inches, 2 Female metric, 6 Viton seal
Type 3	X Standard, 9 Rod extension, 0 Special
Mountings	A Front flange rectangular, B Rear flange rectangular, C Front flange round, D Rear flange round, E Rear clevis square, F Rear clevis round, G Foot, H Centre trunnion, I Intermediate trunnion, J Basic
Bore size	40, 50, 65, 75, 100, 125, 150

• Custom made hydraulic cylinder can be made on request.

Front and rear flange mounting

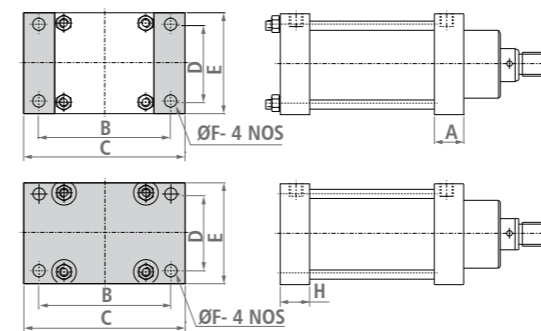

Bore	40	50	65	75	100	125	150
A	35	35	41	42	56	56	58
B	90	100	106	132	188	230	256
C	112	120	130	158	228	280	306
D	47	50	55	75	100	125	148
E	69	74	82	102	140	175	198
F	11	11	11	13	22	26	26
H	36	40	46	46	60	65	65

Clevis, foot, intermediate trunnion and front trunnion mounting

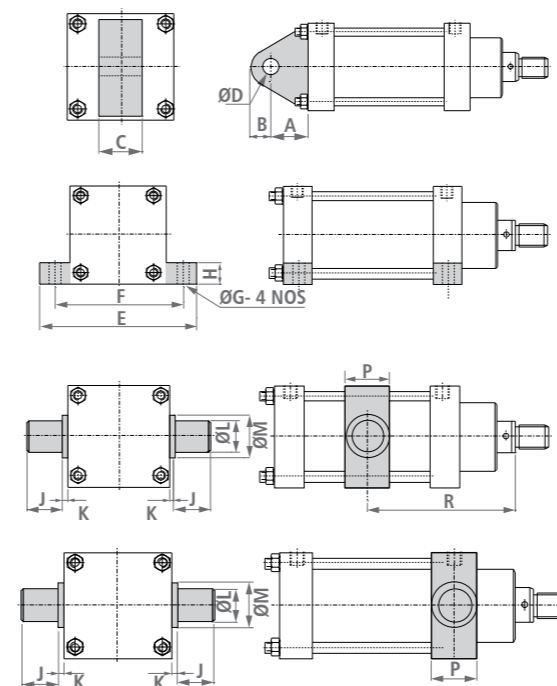

Bore	40	50	65	75	100	125	150
A	30	36	36	43	62	72	85
B	18	22	22	28	40	50	55
C	20	30	30	40	50	60	65
D	15	20	20	25	35	45	50
E	116	120	130	158	228	280	306
F	96	100	106	132	188	230	256
G	11	11	13	13	22	26	26
H	15	20	25	25	30	40	40
J	30	35	35	44	44	44	50
K	5	5	5	5	5	5	5
L	30	35	35	44	44	44	50
M	40	50	50	60	60	67	85
P	40	50	50	60	60	67	85
R	Customer to specify						



Front flange and rear clevis mounting, round type

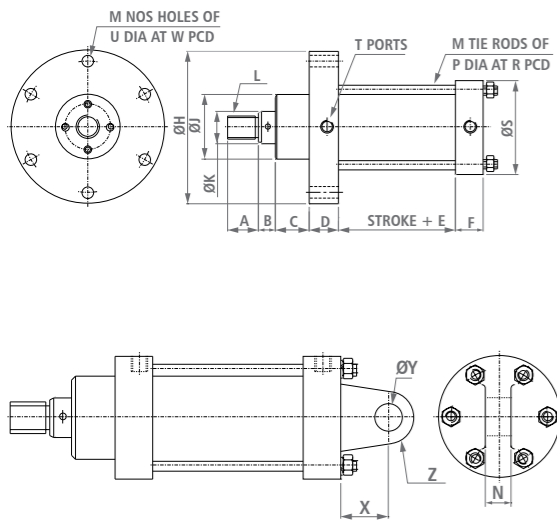

Bore	40	50	65	75	100	125	150	200	250	300
A	26	26	32	50	50	50	64	76	80	120
B	16	16	19	26	26	26	30	30	30	35
C	47	47	47	61	60	60	60	59	59	70
D	32	34	41	42	56	56	58	59	59	62
*E	65	65	77	85	92	102	107	119	129	139
F	24	26	32	32	45	45	45	48	48	62
H	115	145	157	185	265	295	350	415	480	550
J	68	68	77	100	115	115	146	167	195	261
K	25.6	25.6	35.1	45.8	58.4	58.4	85.8	103	130.5	181.5
L	M20X2.5	M20X2.5	M24X3	M33X3.5	M45X4.5	M45X4.5	M70X3	M75X3	M100X3	M150X5
M	6	6	6	6	6	6	6	8	10	16
N	20	30	30	40	50	60	65	75	100	120
P	8	10	10	12	20	20	24	24	24	24
R	60	77	88	105	141.5	172.5	204	267	332	403
S	77	98	110	130	180	210	251	315	380	450
T	G 1/4	G 3/8	G 1/2	G 1/2	G 3/4	G 3/4	G 3/4	G 3/4	G 3/4	G 3/4
U	9	11	11	13	22	22	26	26	26	26
W	96	122	135	160	225	255	305	370	435	505
X	30	36	36	43	62	72	85	120	150	170
Y	15	20	20	25	35	45	50	75	100	120
Z	R 18	R 22	R 22	R 28	R 40	R 50	R 55	R 90	R 120	R 140



From simple single pump-motor power packs to sophisticated multi pump-motor hydraulic systems in open loop, we have the expertise and experience of 30 years to design and build hydraulic power systems to meet your requirement.

Using modern-technology hydraulic elements, modular manifold construction, electrical interlocks and the latest design and building techniques in hydraulics, we can provide our customers with energy-efficient, reliable hydraulic power systems. These power systems can be supplied along with hydraulic cylinders and controls for operation.

Cylinder accessories

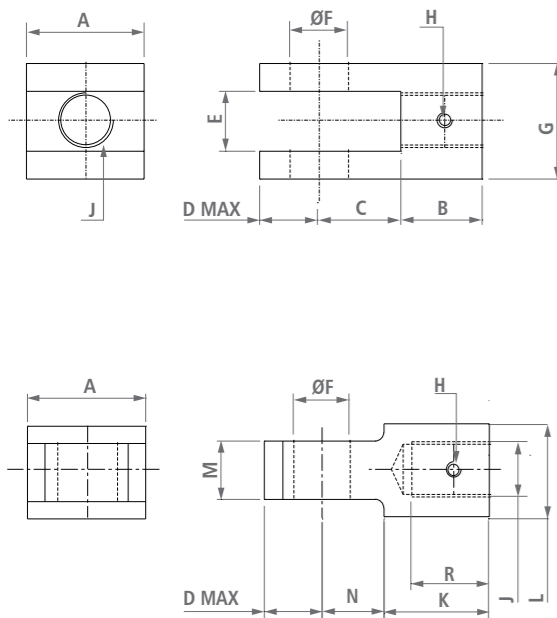

Rod fork and rod yoke

Bore	40	50	65	75	100	125	150
A	36	44	48	56	80	100	110
B	28	28	35	52	52	52	66
C	23	27	29	33	45	55	60
D	18	22	24	28	40	50	55
E	24	30	30	40	50	60	70
F	15	20	20	25	35	43	50
G	48	65	65	86	106	125	140
H	M8	M8	M8	M8	M8	M10	M10
J	M20X2.5	M20X2.5	M24X3	M33X3.5	M45X4.5	M45X4.5	M70X3
K	35	38	50	70	70	—	90
L	30	30	36	46	60	—	86
M	20	30	30	40	50	60	70
N	27	32	32	36	50	120	68
R	26	26	32	50	50	50	64

Options

- Fixed displacement or variable displacement pump systems
- Conventional, proportional or servo technology valve system
- Flow handling capacities of up to 1000 lpm, pressures up to 700 bar
- All systems are built to cleanliness level of NAS class 6
- Electric servo pump driven system for superior energy efficiency
- Intensifiers for high pressure applications up to 2000 bar are available
- Clean rust-proof stainless steel tank power systems for pharmaceutical, food industry and special applications
- Systems suitable for water glycol and other fire resistant fluids also available

• For complete details, refer Product Data Sheet.

Pneumo-Hydraulic Booster Pumps



Features

- Design of pressure intensification up to 1000 bar
- Works on the principle of different bore area ratios
- Suitable for oil, water and various other fluids
- Available in various bore area ratios
- Option: Double-acting booster pumps with higher displacement per stroke, higher capacity hydraulic tanks
- Application: Pressure testing of valves, pressure vessels, fittings, hoses and pipes. Used as power source for clamp heads, hydraulic actuators and expansion of AC condenser coils

Specifications

Model No./Ordering Code	FBP1:013T1	FBP1:019T1	FBP1:035T1	FBP1:064T1	FBP1:144T1
Bore area ratio	01:13	01:19	01:35	1:64	1:144
Displacement per stroke (cc)	100	100	50	12	12
Maximum pneumatic input pressure (psi)	100	100	100	100	100
Minimum pneumatic input pressure (psi)	25	25	25	25	25
Hydraulic outlet pressure when operated at 100 psi pneumatic input pressure (psi)	1300	1900	3500	6400	14400
Hydraulic tank capacity (ltr.)	75	75	75	75	75
Type	Pneumo-hydraulic, single-acting, self reciprocating				
Actuation	By means of 4 way 5 port double pilot operated directional control valve				

Speciality Products



Hydraulic jacks used in construction industry

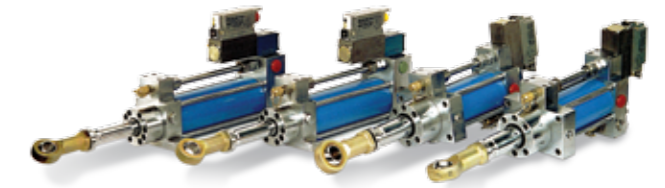

Servo cylinders for precision control in industrial testing equipment and SPMs



Stainless steel cylinders used in chemical plants, food and pharmaceutical industry



Swing clamp cylinders with locking arrangement and valve stand for machine tools, SPMs, high temperature furnaces, etc.



Large bore single-acting cylinders used in big hydraulic presses



EPCN hydraulic cylinders in bore size 40, 50, 63, 80, 100, 110 and 125 for die casting machines



Compact type hydraulic cylinders in bore size 40, 50, 63, 80, 100, 110 and 125



Special type pneumatic cylinder with manual override

• For complete details, refer Product Data Sheet.

Electropneumatics & Hydraulics (India) Pvt. Ltd.

Gat No. 254/255, Kharabe Wadi, Chakan-Talegaon Road,
Chakan, Pune 410501, India.

Tel. : +91 2135 667500

Fax. : +91 2135 667502

pneumatics@electropneumatics.com

www.electropneumatics.com